

Technical data :	
Operating voltage	10...30 V DC
Rated current	2 A
Insulation resistance	> 1000 MΩ
Ambient temperature range	-25...70 °C
Protection :	
Protection degree	IP65
M8 straight male connector :	
Locking nut/screw material	CuZn, nickel-plated
Overmoulding material	TPU, self-extinguishing
Contact diameter	Ø1 mm
Contact material	CuZn, pre-plated with nickel and gold-plated
Contact resistance	< 5 mΩ
M8 angled female connector (LEDs) :	
Locking nut/screw material	CuZn, nickel-plated
Spot welding splash protection sleeve	
Overmoulding material	TPU, self-extinguishing
Contact diameter	Ø1 mm
Contact material	CuZn, pre-plated with nickel and gold-plated
Contact resistance	< 5 mΩ
LED(s) colour	LEDs (YE / GN)
Compatibility type	PNP
Current consumption per LED	< 4 mA
Status indication :	
Signal (4)	Yellow LED
Power	Green LED
Cable characteristics :	
Sheath material	PVC
Wire structure	3 x 0,25 mm ²
Conductor class	5
Sheath diameter	3,7 mm
Flame resistance according to	IEC 60332-1 (VDE 0472-804/B)
Cable protection characteristics :	
Silicone rubber on fiberglass braided sleeving	
Max. contact temperature	+250°C (peak +290°C)
Cable length :	
L length	5 m
Other length	On request
Accessories (included) :	
2 label holders	

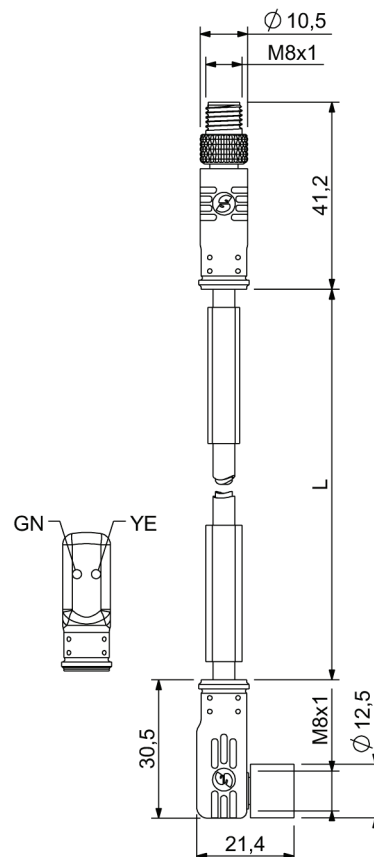

Dimensions :



Wiring diagram :

