

Technical data :

Operating voltage	10...30 V DC
Rated current	2 A
Insulation resistance	> 1000 MΩ
Ambient temperature range	-25...70 °C

Protection :

Protection degree	IP65
-------------------	------

M8 straight male connector :

Locking nut/screw material	CuZn, nickel-plated
Overmoulding material	TPU, self-extinguishing
Contact diameter	Ø1 mm
Contact material	CuZn, pre-plated with nickel and gold-plated
Contact resistance	< 5 mΩ

M8 angled female connector (LEDs) :

Locking nut/screw material	CuZn, nickel-plated
Spot welding splash protection sleeve	
Overmoulding material	TPU, self-extinguishing
Contact diameter	Ø1 mm
Contact material	CuZn, pre-plated with nickel and gold-plated
Contact resistance	< 5 mΩ
LED(s) colour	LEDs (YE / GN)
Compatibility type	PNP
Current consumption per LED	< 4 mA

Status indication :

Signal (4)	Yellow LED
Power	Green LED

Cable characteristics :

Sheath material	PVC
Wire structure	3 x 0,25 mm ²
Conductor class	5
Sheath diameter	3,7 mm
Flame resistance according to	IEC 60332-1 (VDE 0472-804/B)

Cable protection characteristics :

Silicone rubber on fiberglass braided sleeving	
Max. contact temperature	+250°C (peak +290°C)

Cable length :

L length	0,6 m
Other length	On request

Accessories (included) :

2 label holders

T8V/3MLP0065TS

Welding environment

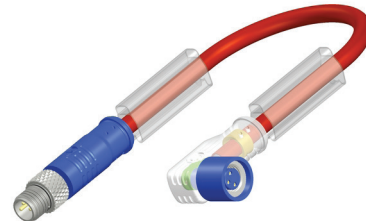

Dimensions :

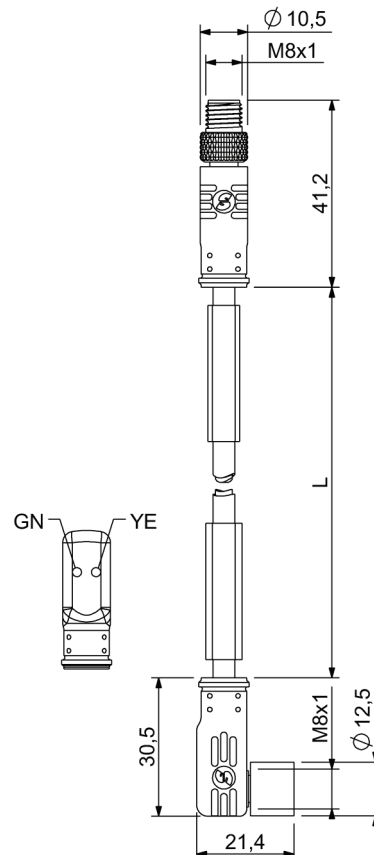

Wiring diagram :

