

**Technical data :**

Operating voltage	10...30 V DC
Rated current	4 A
Insulation resistance	> 1000 MΩ
Ambient temperature range	-25...70 °C

**Protection :**

Protection degree	IP65
-------------------	------

**M12 straight male connector :**

Locking nut/screw material	Zamak, nickel-plated
Overmoulding material	TPU, self-extinguishing
Contact diameter	Ø1 mm
Contact material	CuZn, pre-plated with nickel and gold-plated
Contact resistance	< 5 mΩ

**M12 angled female connector (LEDs) :**

Locking nut/screw material	Zamak, nickel-plated
Spot welding splash protection sleeve	
Overmoulding material	TPU, self-extinguishing
Contact diameter	Ø1 mm
Contact material	CuZn, pre-plated with nickel and gold-plated
Contact resistance	< 5 mΩ
LED(s) colour	LEDs (YE / RD / GN)
Compatibility type	PNP
Current consumption per LED	< 5 mA

**Status indication :**

Signal (2)	Red LED
Signal (4)	Yellow LED
Power	Green LED

**Cable characteristics :**

Sheath material	PVC
Wire structure	5 G 0,34 mm <sup>2</sup>
Conductor class	6
Sheath diameter	5,8 mm
Flame resistance according to	IEC 60332-1 (VDE 0472-804/B)

**Cable protection characteristics :**

Aramid fiber (kevlar) braided sleeving	
Max. contact temperature	+250°C (peak +330°C)

**Cable length :**

L length	5 m
Other length	On request

**Accessories (included) :**

2 label holders

## T12/5MLP355VTK

Welding environment



**Dimensions :**

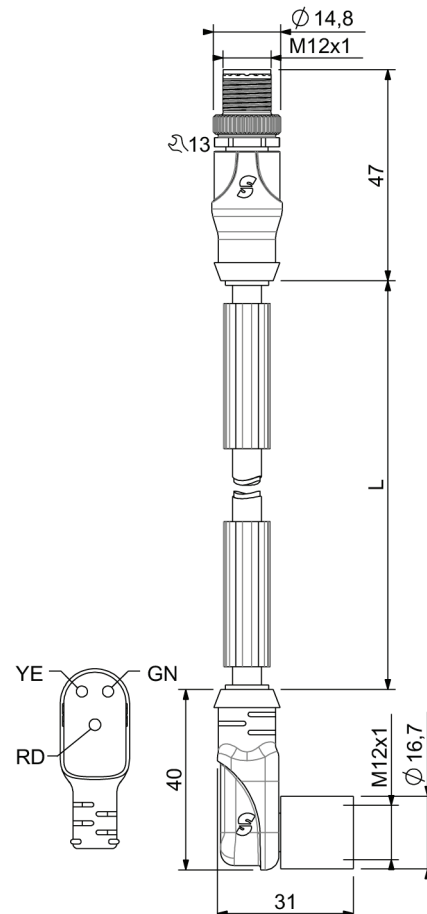

**Wiring diagram :**

