

### Technical data :

Operating voltage	10...30 V DC
Rated current	4 A
Insulation resistance	> 1000 MΩ
Ambient temperature range	-25...70 °C

### Protection :

Protection degree	IP65
-------------------	------

### M12 straight male connector :

Locking nut/screw material	Zamak, nickel-plated
Overmoulding material	TPU, self-extinguishing
Contact diameter	Ø1 mm
Contact material	CuZn, pre-plated with nickel and gold-plated
Contact resistance	< 5 mΩ

### M12 angled female connector (LEDs) :

Locking nut/screw material	Zamak, nickel-plated
Spot welding splash protection sleeve	
Overmoulding material	TPU, self-extinguishing
Contact diameter	Ø1 mm
Contact material	CuZn, pre-plated with nickel and gold-plated
Contact resistance	< 5 mΩ
LED(s) colour	LEDs (YE / YE / GN)
Compatibility type	PNP
Current consumption per LED	< 5 mA

### Status indication :

Signal (2)	Yellow LED
Signal (4)	Yellow LED
Power	Green LED

### Cable characteristics :

Sheath material	PVC
Wire structure	5 G 0,34 mm <sup>2</sup>
Conductor class	6
Sheath diameter	5,8 mm
Flame resistance according to	IEC 60332-1 (VDE 0472-804/B)

### Cable protection characteristics :

Silicone rubber-coated fiberglass braided sleeving	
Max. contact temperature	+250°C (peak +290°C)

### Cable length :

L length	5 m
----------	-----

### Accessories (included) :

2 label holders

## T12/5MLP355TS

Welding environment

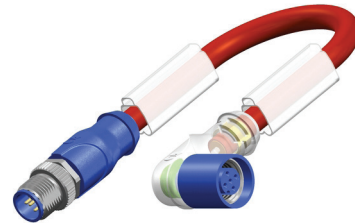

RoHS

### Dimensions :

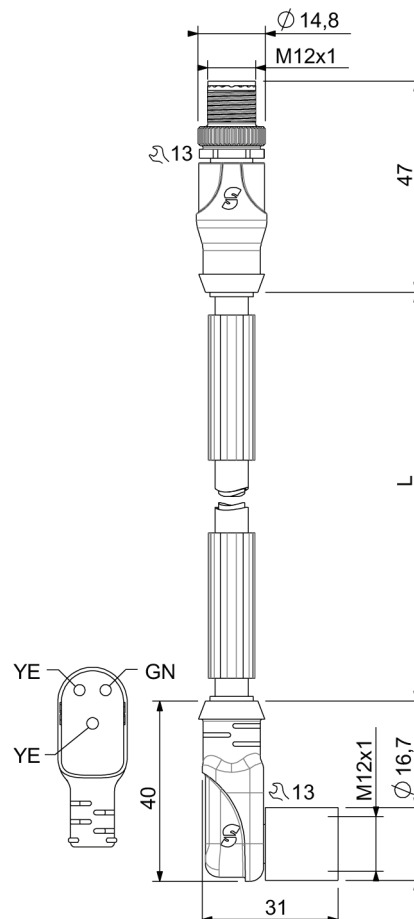

### Wiring diagram :

