

Technical data :	
Operating voltage	10...30 V DC
Rated current	4 A
Insulation resistance	> 1000 MΩ
Ambient temperature range	-25...70 °C

Protection :	
Protection degree	IP65

M12 straight male connector :	
Locking nut/screw material	Zamak, nickel-plated
Overmoulding material	TPU, self-extinguishing
Contact diameter	Ø1 mm
Contact material	CuZn, pre-plated with nickel and gold-plated
Contact resistance	< 5 mΩ

M12 angled female connector (LEDs) :	
Locking nut/screw material	Zamak, nickel-plated
Spot welding splash protection sleeve	
Overmoulding material	TPU, self-extinguishing
Contact diameter	Ø1 mm
Contact material	CuZn, pre-plated with nickel and gold-plated
Contact resistance	< 5 mΩ
LED(s) colour	LEDs (YE / YE / GN)
Compatibility type	PNP
Current consumption per LED	< 5 mA

Status indication :	
Signal (2)	Yellow LED
Signal (4)	Yellow LED
Power	Green LED

Cable characteristics :	
Sheath material	PVC
Wire structure	5 G 0,34 mm ²
Conductor class	6
Sheath diameter	5,8 mm
Flame resistance according to	IEC 60332-1 (VDE 0472-804/B)

Cable protection characteristics :	
Aramid fiber (kevlar) braided sleeving	
Max. contact temperature	+250°C (peak +330°C)

Cable length :	
L length	2 m
Other length	On request

Accessories (included) :	
2 label holders	

T12/5MLP325TK

Welding environment

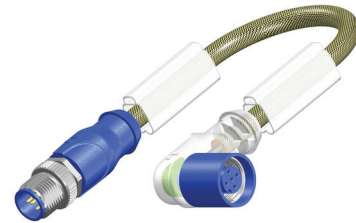

Dimensions :

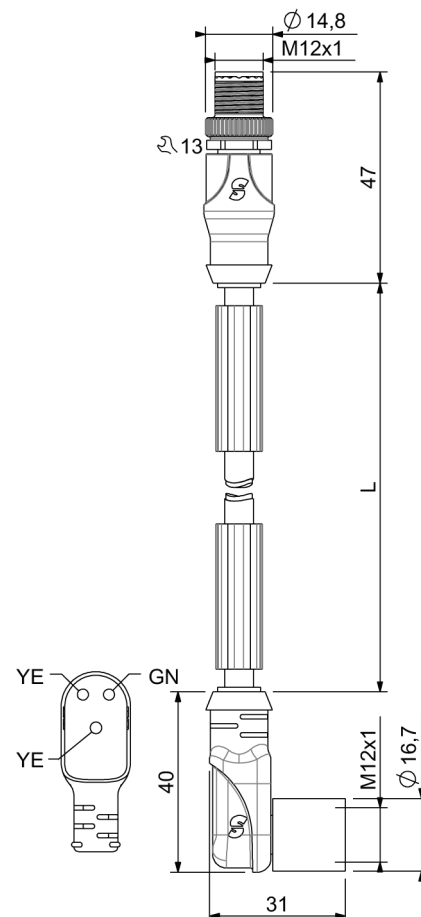

Wiring diagram :

