

Technical data :

Rated voltage	48 V AC/DC
Rated current	4 A
Insulation resistance	> 1000 MΩ
Ambient temperature range	-25...70 °C

Protection :

Protection degree	IP65
-------------------	------

M12 angled female connector :

Locking nut/screw material	Zamak, nickel-plated
Spot welding splash protection sleeve	
Overmoulding material	TPU, self-extinguishing
Contact diameter	Ø1 mm
Contact material	CuZn, pre-plated with nickel and gold-plated
Contact resistance	< 5 mΩ

Cable characteristics :

Sheath material	PVC
Wire structure	4 x 0,34 mm ²
Conductor class	6
Sheath diameter	5 mm
Flame resistance according to	IEC 60332-1 (VDE 0472-804/B)

Cable protection characteristics :

Silicone rubber-coated fiberglass braided sleeving	
Max. contact temperature	+250°C (peak +290°C)

Cable length :

L length	3 m
----------	-----

Accessories (included) :

1 label holder

T12/4C35TS

Welding environment



Dimensions :

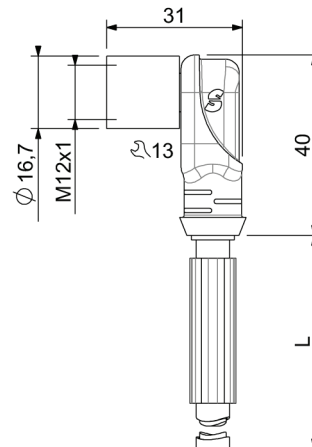

Wiring diagram :

