

Technical data :	
Rated voltage	48 V AC/DC
Rated current	4 A
Insulation resistance	> 1000 MΩ
Ambient temperature range	-25...70 °C
Protection :	
Protection degree	IP67
M12 angled male connector :	
Locking nut/screw material	Zamak, nickel-plated
Overmoulding material	TPU, self-extinguishing
Contact diameter	Ø1 mm
Contact material	CuZn, pre-plated with nickel and gold-plated
Contact resistance	< 5 mΩ
M12 angled female connector :	
Locking nut/screw material	Zamak, nickel-plated
Overmoulding material	TPU, self-extinguishing
Contact diameter	Ø1 mm
Contact material	CuZn, pre-plated with nickel and gold-plated
Contact resistance	< 5 mΩ
Cable characteristics :	
Sheath material	Halogen free PUR
Wire structure	4 x 0,34 mm <sup>2</sup>
Conductor class	6
Sheath diameter	4,7 mm
Cable construction according to UL-AWM Style 20549/10493	
Halogen free cable according to DIN VDE 0472 Part 815	
Cable silicone free and LABS free according to PV 3.10.7	
Flame resistance according to	UL FT2
Oil resistance according to	UL 758
Drag chain suitable	
Minimum static bending radius : 5 x Ø	
Minimum dynamic bending radius : 10 x Ø	
Cable length :	
L length	5 m
Other length	On request
Accessories (included) :	
2 label holders	

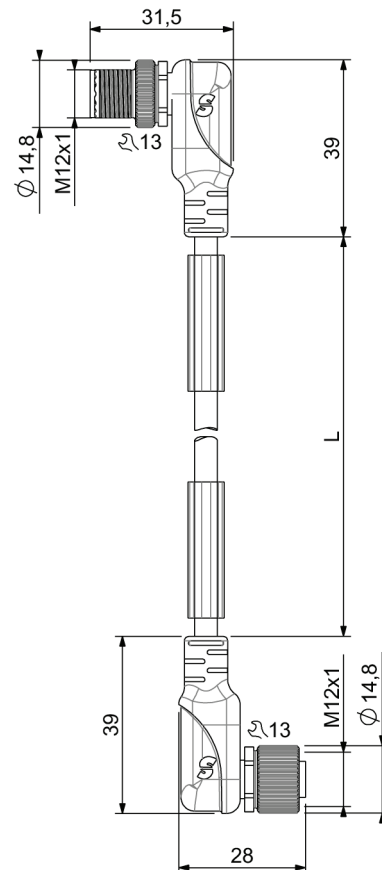

**Dimensions :**



**Wiring diagram :**

