

### Technical data :

Rated voltage	48 V AC/DC
Rated current	4 A
Insulation resistance	> 1000 MΩ
Ambient temperature range	-25...70 °C

### Protection :

Protection degree	IP67
-------------------	------

### M12 angled female connector :

Locking nut/screw material	Zamak, nickel-plated
Overmoulding material	TPU, self-extinguishing
Contact diameter	Ø1 mm
Contact material	CuZn, pre-plated with nickel and gold-plated
Contact resistance	< 5 mΩ

### Cable characteristics :

Sheath material	Halogen free PUR
Wire structure	4 x 0,34 mm <sup>2</sup>
Conductor class	6
Sheath diameter	5,3 mm

Minimal sheath (wall) thickness > 1 mm

Cable construction according to UL-AWM Style 20549/10493

Halogen free cable according to DIN VDE 0472 Part 815

Cable silicone free and LABS free according to PV 3.10.7

Flame resistance according to UL FT2

Oil resistance according to UL 758

Admissible torsion +/- 360 °/ m

Drag chain suitable

Minimum static bending radius : 5 x Ø

Minimum dynamic bending radius : 10 x Ø

Resistant to weld splatters

### Cable length :

L length 15 m

Other length On request

### Accessories (included) :

1 label holder



### Dimensions :

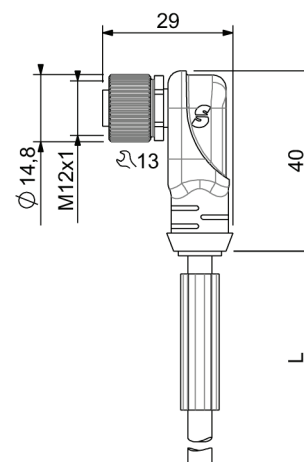

### Wiring diagram :

