

Technical data :	
Operating voltage	10...55V DC
Nominal current per signal	4 A
Total current	12 A
Insulation resistance	> 1000 MΩ
Ambient temperature range	-25...70 °C
Protection :	
Protection degree	IP67
Materials :	
Housing	Anodized aluminium
Potting	PUR (UL94-V0 self-extinguishing)
M12 female receptacle :	
Receptacle material	CuZn, nickel-plated
Contact diameter	5 x Ø1 mm
Contact material	CuZn, pre-plated with nickel and gold-plated
Contact resistance	< 5 mΩ
Cable characteristics :	
Sheath material	Halogen free PUR
Wire structure	3 G 1 mm ² + 8 x 0,34 mm ²
Conductor class	6
Sheath diameter	8,7 mm
Flame resistance according to	IEC 60332-1 (VDE 0472-804/B)
Oil resistance according to	EN 50363 & IEC 60811-2-1 & CNOMO
Cable length :	
L length	15 m
Other length	On request
Accessories (included) :	
5 label holders (KM6/27)	
2 caps (OBTM12)	

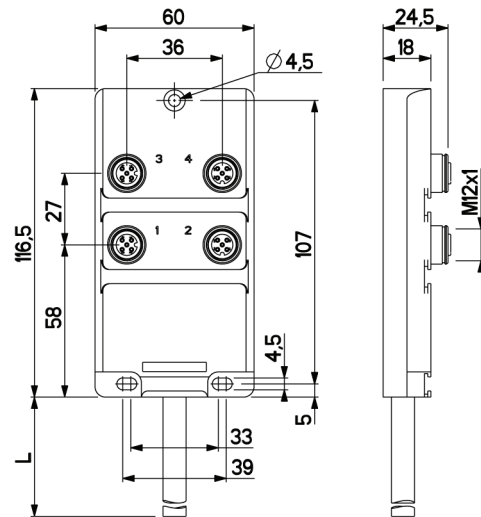

Dimensions :



Wiring diagram :

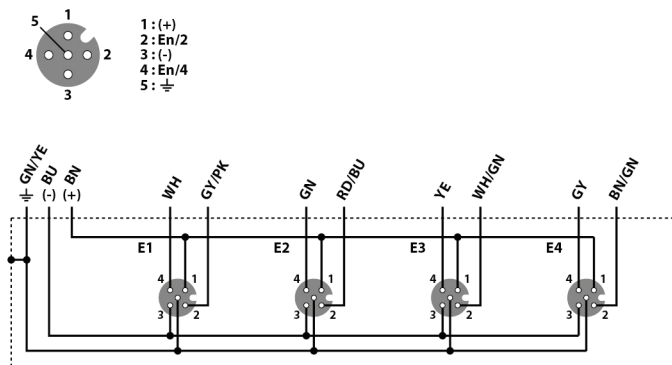

For uses in particularly harsh environments: Please enquire

We reserve the right to modify all or part of characteristics of our products without warning.

Printed on:

22 juil. 2019