

LBI24/3C51

Industrial automation



Technical data :

| | |
|---------------------------|-------------|
| Rated voltage | 24 V AC/DC |
| Rated current | 4 A |
| Ambient temperature range | -10...70 °C |

Protection :

| | |
|-------------------|------|
| Protection degree | IP67 |
|-------------------|------|

Solenoid valve connector (Form B Industrial) :

| | |
|-------------------------------------|---------------------------------|
| Overmoulding material | TPU, self-extinguishing |
| Contact centre distance | 11 mm |
| Contact material | CuSn |
| Integrated interference suppression | Transil diode |
| Diode nominal voltage | 42 V @ 1 mA |
| Diode peak-limiting voltage | 58 V @ 10,3 A |
| Max. peak pulse power | 600 W @ 25 °C (pulse 10/1000µs) |
| LED(s) colour | Green LED |
| Compatibilité LED(s) | PNP |
| Current consumption per LED | < 5 mA |

Status indication :

| | |
|--------|-----------|
| Signal | Green LED |
|--------|-----------|

Cable characteristics :

| | |
|-------------------------------|------------------------------|
| Sheath material | PVC |
| Wire structure | 3 G 0,50 mm ² |
| Conductor class | 5 |
| Sheath diameter | 5,7 mm |
| Flame resistance according to | IEC 60332-1 (VDE 0472-804/B) |
| Oil resistance according to | CNOMO E03.40.150.N |

Cable length :

| | |
|--------------|------------|
| L length | 5 m |
| Other length | On request |

Accessories (included) :

- 1 captive screw on the solenoid valve connector
- 1 sticker on the solenoid valve connector
- 1 label holder

Dimensions :

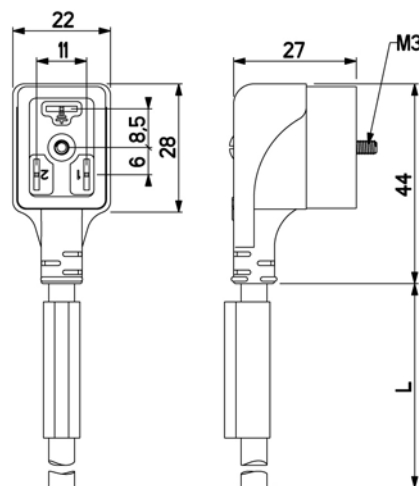

Wiring diagram :

