

**Technical data :**

Rated voltage	60 V DC
Rated current	6 A (Ø1mm) / 10 A (Ø1,5mm)
Insulation resistance	> 100 MΩ
Ambient temperature range	-40...90 °C

**Protection :**

Protection degree	IP67
-------------------	------

**M23 angled male connector :**

Locking nut/screw material	Zamak, nickel-plated
Overmoulding material	TPU, self-extinguishing
Contact diameter	16 x Ø1 mm + 3 x Ø1,5 mm
Contact material	CuZn, pre-plated with nickel and gold-plated
Contact resistance	< 5 mΩ
Ground contact (N°12) connected to metal body of connector	

**M23 angled female connector :**

Locking nut/screw material	CuZn, nickel-plated
Overmoulding material	TPU, self-extinguishing
Contact diameter	16 x Ø1 mm + 3 x Ø1,5 mm
Contact material	CuZn, pre-plated with nickel and gold-plated
Contact resistance	< 5 mΩ
Ground contact (N°12) connected to metal body of connector	

**Cable characteristics :**

Sheath material	Halogen free PUR
Wire structure	3 G 1 mm <sup>2</sup> + 16 x 0,34 mm <sup>2</sup>
Conductor class	6
Sheath diameter	10,9 mm
Flame resistance according to	IEC 60332-1 (VDE 0472-804/B)
Oil resistance according to	EN 50363 & IEC 60811-2-1 & CNOMO

**Cable length :**

L length	25 m
Other length	On request

**Accessories (included) :**

2 label holders

## L2319MCC255

Oil environment



**Dimensions :**

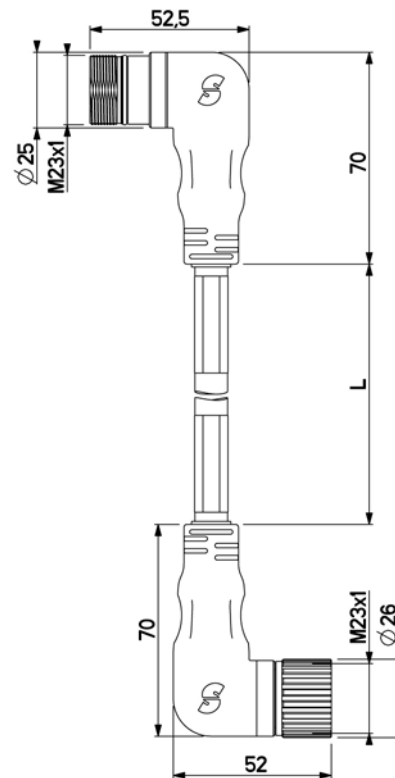

**Wiring diagram :**

