

Technical data :

Rated voltage	60 V DC
Rated current	6 A (Ø1mm) / 10 A (Ø1,5mm)
Insulation resistance	> 100 MΩ
Ambient temperature range	-40...90 °C

Protection :

Protection degree	IP67
-------------------	------

M23 angled male connector :

Locking nut/screw material	Zamak, nickel-plated
Overmoulding material	TPU, self-extinguishing
Contact diameter	16 x Ø1 mm + 3 x Ø1,5 mm
Contact material	CuZn, pre-plated with nickel and gold-plated
Contact resistance	< 5 mΩ
Ground contact (N°12) connected to metal body of connector	

M23 angled female connector :

Locking nut/screw material	CuZn, nickel-plated
Overmoulding material	TPU, self-extinguishing
Contact diameter	16 x Ø1 mm + 3 x Ø1,5 mm
Contact material	CuZn, pre-plated with nickel and gold-plated
Contact resistance	< 5 mΩ
Ground contact (N°12) connected to metal body of connector	

Cable characteristics :

Sheath material	Halogen free PUR
Wire structure	3 G 1 mm ² + 16 x 0,34 mm ²
Conductor class	6
Sheath diameter	10,9 mm
Flame resistance according to	IEC 60332-1 (VDE 0472-804/B)
Oil resistance according to	EN 50363 & IEC 60811-2-1 & CNOMO

Cable length :

L length	5 m
Other length	On request

Accessories (included) :

2 label holders

L2319MCC055

Oil environment



Dimensions :

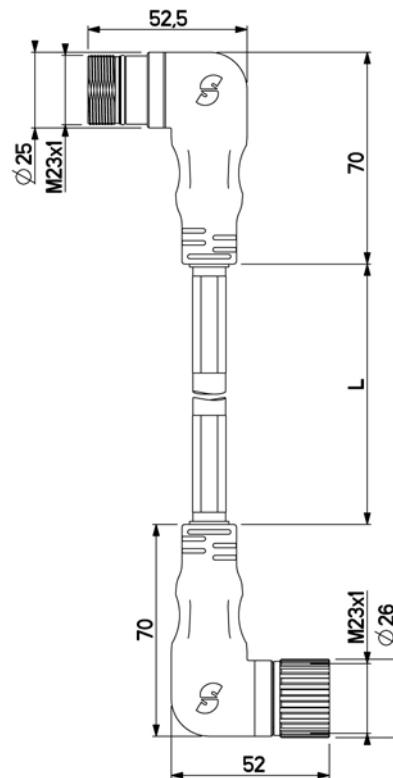

Wiring diagram :

