

Technical data :

Rated voltage	48 V DC
Rated current	4 A (Ø1mm) / 8 A (Ø1,5mm)
Insulation resistance	> 100 MΩ
Ambient temperature range	-40...80 °C

Protection :

Protection degree	IP67
-------------------	------

M23 angled female connector :

Locking nut/screw material	CuZn, nickel-plated
Overmoulding material	TPU, self-extinguishing
Contact diameter	16 x Ø1 mm + 3 x Ø1,5 mm
Contact material	CuZn, pre-plated with nickel and gold-plated
Contact resistance	< 5 mΩ
Ground contact (N°12) connected to metal body of connector	

Cable characteristics :

Sheath material	Halogen free PUR
Wire structure	20 G 0,50 mm ²
Conductor class	6
Sheath diameter	11,5 mm
UL-AWM Style 21576 certified cable	
Flame resistance according to	UL FT2 / IEC 60332-1-2
Drag chain suitable	

Cable length :

L length	25 m
Other length	On request

Accessories (included) :

1 label holder

L2319C252U

Specific



Dimensions :

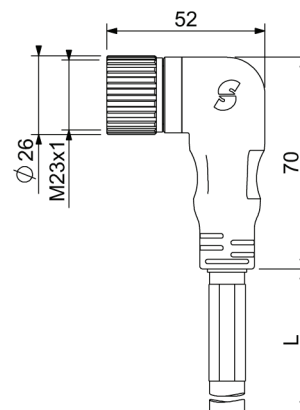

Wiring diagram :

