

Technical data :

Rated voltage	60 V DC
Rated current	4 A
Insulation resistance	> 100 MΩ
Ambient temperature range	-25...70 °C

Protection :

Protection degree	IP67
-------------------	------

M23 straight male connector :

Locking nut/screw material	Zamak, nickel-plated
Overmoulding material	TPU, self-extinguishing
Contact diameter	16 x Ø1 mm + 3 x Ø1,5 mm
Contact material	CuZn, pre-plated with nickel and gold-plated
Contact resistance	< 5 mΩ
Ground contact (N°12) connected to metal body of connector	

Connector 7/8" :

Locking nut/screw material	Anodized aluminium
Contact diameter	Ø1,98 mm
Contact material	CuZn, silver and gold-plated
Contact resistance	< 5 mΩ
Connection type	Screw connection (max. 1 mm ²)
Hood material	PA

Cable characteristics :

Sheath material	PVC
Wire structure	5 G 0,34 mm ²
Conductor class	6
Sheath diameter	5,8 mm
Flame resistance according to	IEC 60332-1 (VDE 0472-804/B)
Oil resistance according to	CNOMO E03.40.150.N

Cable length :

L length	1,5 m
Other length	On request

L231978/5MLL0155

Industrial automation



Dimensions :

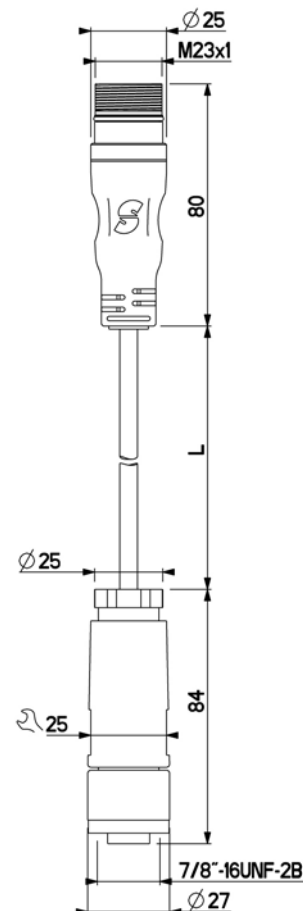

Wiring diagram :

