

Technical data :

Operating voltage	10...30 V DC
Rated current	4 A
Insulation resistance	> 1000 MΩ
Ambient temperature range	-25...70 °C

Protection :

Protection degree	IP67
-------------------	------

M12 straight male connector :

Locking nut/screw material	Zamak, nickel-plated
Overmoulding material	TPU, self-extinguishing
Contact diameter	Ø1 mm
Contact material	CuZn, pre-plated with nickel and gold-plated
Contact resistance	< 5 mΩ

M12 angled female connector (LEDs) :

Locking nut/screw material	Zamak, nickel-plated
Overmoulding material	TPU, self-extinguishing
Contact diameter	Ø1 mm
Contact material	CuZn, pre-plated with nickel and gold-plated
Contact resistance	< 5 mΩ
LED(s) colour	LEDs (YE / RD / GN)
Compatibility type	PNP
Current consumption per LED	< 5 mA

Status indication :

Signal (2)	Red LED
Signal (4)	Yellow LED
Power	Green LED

Cable characteristics :

Sheath material	Halogen free PUR
Wire structure	5 G 0,34 mm ²
Conductor class	6
Sheath diameter	5,5 mm
Flame resistance according to	IEC 60332-1 (VDE 0472-804/B)
Oil resistance according to	EN 50363 & IEC 60811-2-1 & CNOMO

Cable length :

L length	2 m
Other length	On request

Accessories (included) :

2 label holders

L12/5MLP3R22F

Oil environment

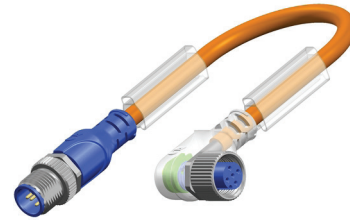

Dimensions :

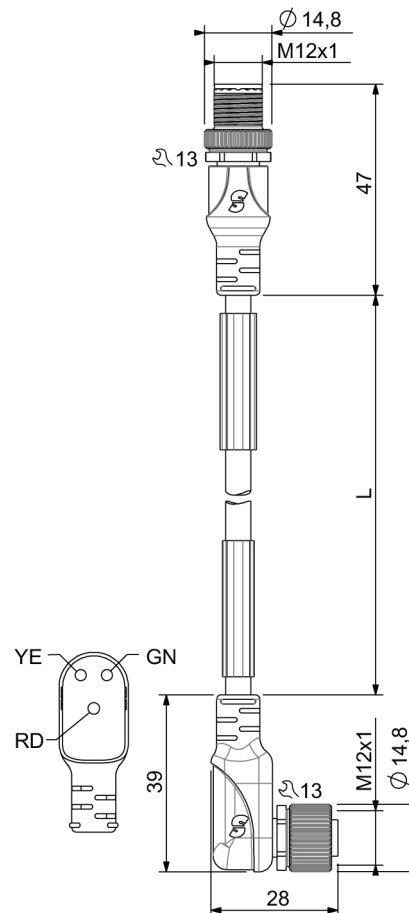

Wiring diagram :

