

Technical data :

Rated voltage	60 V AC/DC
Rated current	4 A
Insulation resistance	> 1000 MΩ
Ambient temperature range	-40...90 °C

Protection :

Protection degree	IP67
-------------------	------

T connector (1 x M12 male + 2 x M12 female) :

Locking nut/screw material	Zamak
Zamak, nickel-plated & Zamak, black PTFE coated	
Overmoulding material	TPU, self-extinguishing
Contact diameter	Ø1 mm
Contact material	CuZn, pre-plated with nickel and gold-plated
Contact resistance	< 5 mΩ
Fixing possible with CHC M4 screws (not supplied)	

Accessories (not included) :

Riser shim (SCT)

L12/5MLLDT4

Industrial automation



Dimensions :

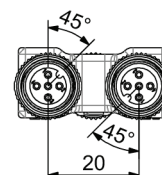
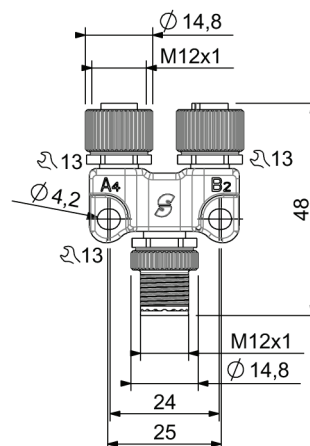
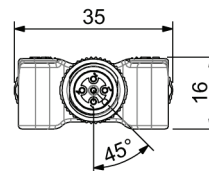

Wiring diagram :

