

Technical data :

Rated voltage	60 V AC/DC
Rated current	4 A
Insulation resistance	> 1000 MΩ
Ambient temperature range	-25...70 °C

Protection :

Protection degree	IP67
-------------------	------

M12 male Y connector :

Locking nut/screw material	Zamak, nickel-plated
Overmoulding material	TPU, self-extinguishing
Contact diameter	Ø1 mm
Contact material	CuZn, pre-plated with nickel and gold-plated
Contact resistance	< 5 mΩ

M12 straight female connector (2x) :

Locking nut/screw material	Zamak, nickel-plated
Overmoulding material	TPU, self-extinguishing
Contact diameter	Ø1 mm
Contact material	CuZn, pre-plated with nickel and gold-plated
Contact resistance	< 5 mΩ

Cable characteristics :

Sheath material	PVC
Wire structure	5 G 0,34 mm ²
Conductor class	6
Sheath diameter	5,8 mm
Flame resistance according to	IEC 60332-1 (VDE 0472-804/B)

Cable length :

L length	5 m
Other length	On request

Accessories (included) :

2 label holders

Notes :

X : Coloured marker

L12/5MLLD55M

Industrial automation

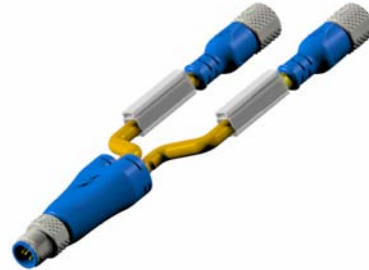

Dimensions :

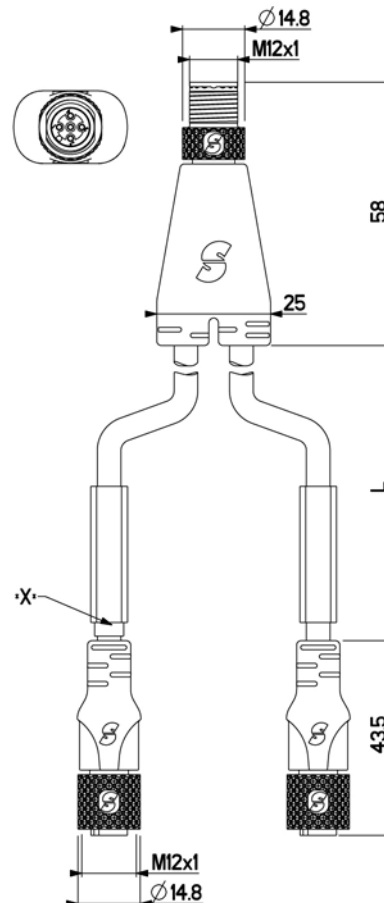

Wiring diagram :

