

Technical data :	
Rated voltage	24 V AC/DC
Rated current	4 A
Ambient temperature range	-25...80 °C
Protection :	
Protection degree	IP67
M12 male Y connector :	
Locking nut/screw material	Zamak, nickel-plated
Overmoulding material	TPU, self-extinguishing
Contact diameter	Ø1 mm
Contact material	CuZn, pre-plated with nickel and gold-plated
Contact resistance	< 5 mΩ
Solenoid valve connector (DIN Form C) :	
Contact centre distance	8 mm
Contact material	CuZn, Cu/Sn
Contact resistance	< 10 mΩ
Integrated interference suppression	Transil diode
LED(s) colour	Yellow LED
Status indication :	
Signal	Yellow LED
Cable characteristics :	
Cable material	Halogen free PUR
Wire structure	3 G 0,50 mm ²
Cable diameter	4,6 mm
Cable length :	
L length	2 m
Other length	On request
Accessories (included) :	
1 captive screw on the solenoid valve connector	
1 sticker on the solenoid valve connector	
2 label holders	
Notes :	
X : Coloured marker	

L12/5LCD25

Industrial automation

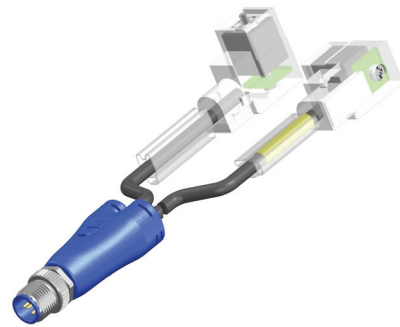

Dimensions :

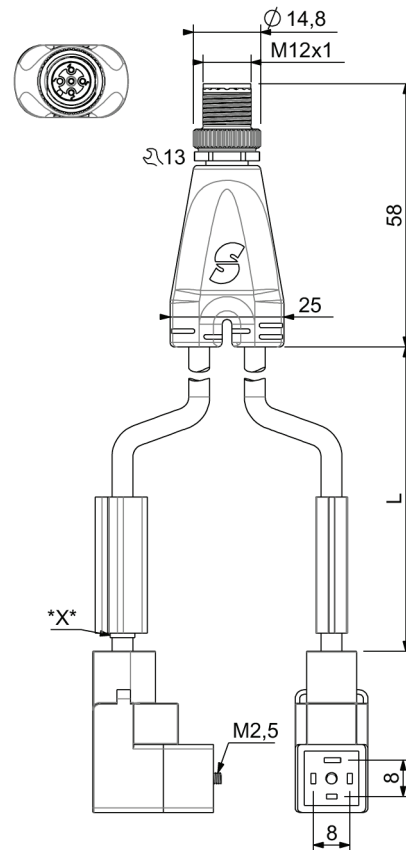

Wiring diagram :

