

Technical data :

Rated voltage	24 V AC/DC
Rated current	4 A
Ambient temperature range	-10...70 °C

Protection :

Protection degree	IP67
-------------------	------

M12 male Y connector :

Locking nut/screw material	Zamak, nickel-plated
Overmoulding material	TPU, self-extinguishing
Contact diameter	Ø1 mm
Contact material	CuZn, pre-plated with nickel and gold-plated
Contact resistance	< 5 mΩ

Solenoid valve connector (Form B Industrial) :

Overmoulding material	TPU, self-extinguishing
Contact centre distance	11 mm
Contact material	CuSn
Integrated interference suppression	Transil diode
Diode nominal voltage	42 V @ 1 mA
Diode peak-limiting voltage	58 V @ 10,3 A
Max. peak pulse power	600 W @ 25 °C (pulse 10/1000µs)
LED(s) colour	Green LED
Compatibility type	PNP
Current consumption per LED	< 5 mA

Status indication :

Signal	Green LED
--------	-----------

Cable characteristics :

Sheath material	PVC
Wire structure	3 G 0,50 mm ²
Conductor class	5
Sheath diameter	5,7 mm
Flame resistance according to	IEC 60332-1 (VDE 0472-804/B)
Oil resistance according to	CNOMO E03.40.150.N

Cable length :

L length	0,6 m
Other length	On request

Accessories (included) :

- 1 captive screw on the solenoid valve connector
- 1 sticker on the solenoid valve connector
- 2 label holders

Notes :

X : Coloured marker

L12/5LBIID0065

Industrial automation

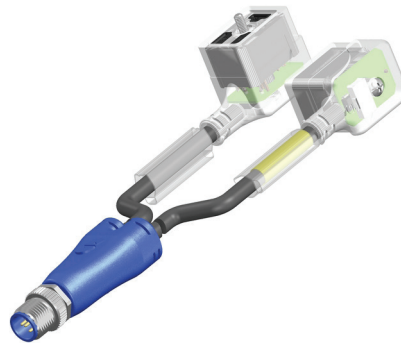

Dimensions :

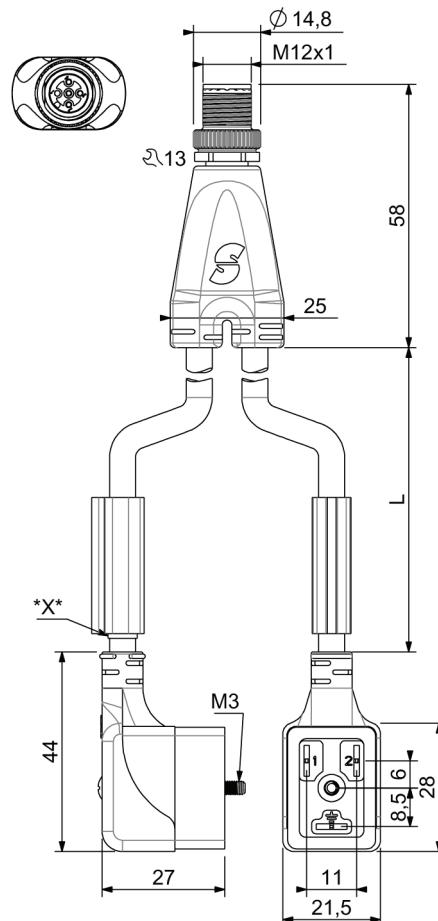

Wiring diagram :

