

### Technical data :

Operating voltage	10...30 V DC
Rated current	4 A
Insulation resistance	> 1000 MΩ
Ambient temperature range	-25...70 °C

### Protection :

Protection degree	IP67
-------------------	------

### M12 angled female connector (LEDs) :

Locking nut/screw material	Zamak, nickel-plated
Overmoulding material	TPU, self-extinguishing
Contact diameter	Ø1 mm
Contact material	CuZn, pre-plated with nickel and gold-plated
Contact resistance	< 5 mΩ
LED(s) colour	LEDs (YE / GN)
Compatibility type	PNP
Current consumption per LED	< 5 mA

### Status indication :

Signal (4)	Yellow LED
Power	Green LED

### Cable characteristics :

Sheath material	Halogen free PUR
Wire structure	4 x 0,34 mm <sup>2</sup>
Conductor class	6
Sheath diameter	5 mm
Flame resistance according to	IEC 60332-1 (VDE 0472-804/B)
Oil resistance according to	EN 50363 & IEC 60811-2-1 & CNOMO
Resistant to weld splatters	

### Cable length :

L length	5 m
Other length	On request

### Accessories (included) :

1 label holder

## L12/4P52

Oil environment



### Dimensions :

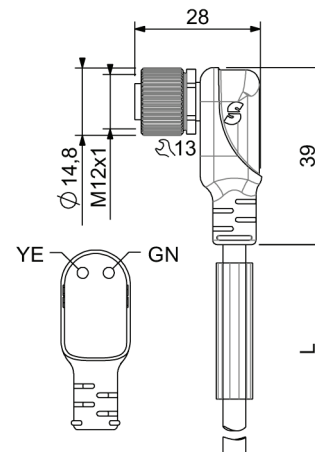

### Wiring diagram :

