

Technical data :	
Operating voltage	10...30 V DC
Rated current	4 A
Insulation resistance	> 1000 MΩ
Ambient temperature range	-25...70 °C
Protection :	
Protection degree	IP67
M12 straight female connector (LEDs) :	
Locking nut/screw material	Zamak, nickel-plated
Overmoulding material	TPU, self-extinguishing
Contact diameter	Ø1 mm
Contact material	CuZn, pre-plated with nickel and gold-plated
Contact resistance	< 5 mΩ
LED(s) colour	LEDs (YE / GN)
Compatibility type	PNP
Current consumption per LED	< 5 mA
Status indication :	
Signal (4)	Yellow LED (*A*)
Power	Green LED (*B*)
Cable characteristics :	
Sheath material	Halogen free PUR
Wire structure	4 x 0,34 mm ²
Conductor class	5
Sheath diameter	5 mm
Flame resistance according to	IEC 60332-1 (VDE 0472-804/B)
Oil resistance according to	EN 50363 & IEC 60811-2-1
Cable length :	
L length	5 m
Other length	On request
Accessories (included) :	
1 label holder	

L12/4LP52H

Industrial automation



Dimensions :

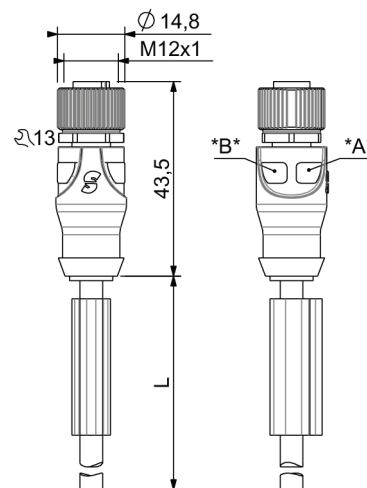

Wiring diagram :

