

Technical data :

Rated voltage	30 V DC
Rated current	4 A
Ambient temperature range	-25...70 °C

Protection :

Protection degree	IP65
-------------------	------

Male HARTING receptacle :

Receptacle material	Metal
Contact diameter	46 x Ø2,5 mm
Contact material	Silver-plated contacts

Right female DEUTSCH connector :

Locking nut/screw material	Aluminium
Contact diameter	42 x Ø1 mm + 5 x Ø1,55 mm
Contact material	Nickel-plated contacts
Hood material	Aluminium

Cable characteristics :

Sheath material	PVC
Wire structure	52 G 0,50 mm ²
Conductor class	5
Sheath diameter	17,3 mm
Flame resistance according to	IEC 60332-1-2
Oil resistance according to	EN 50290-2-22

Cable length :

L length	4,80 m (0/+50 mm)
Other length	On request

H46D47MCL04805W1

Press tools

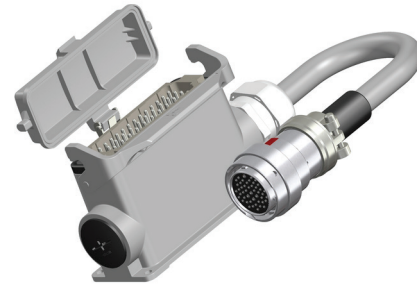

Dimensions :

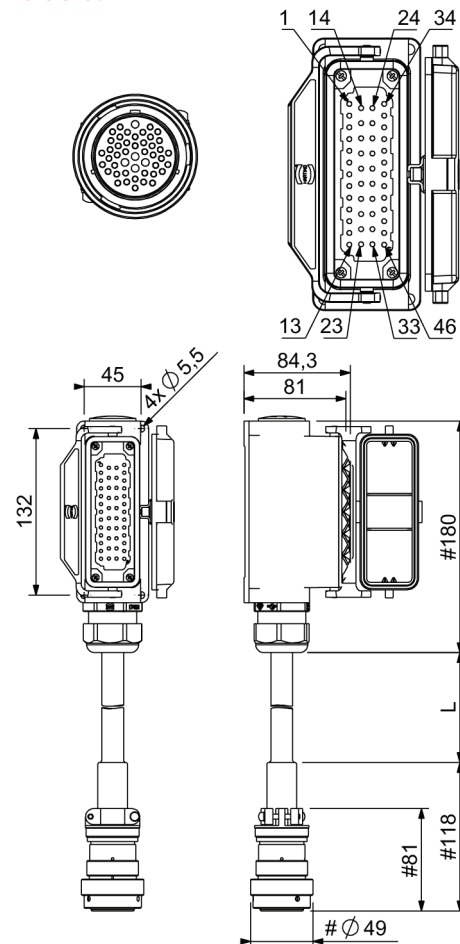

Wiring diagram :

