

Technical data :

Output type	PNP
Function	NO
Operating voltage	10...30V DC
Operating current	200 mA
No-load consumption	< 10 mA
Voltage drop	< 2 V
Residual current	< 70 µA
Ambient temperature range	-25...70 °C
Magnetic sensitivity	2 mT
Hysteresis	3...20 %
Repeatability	< 5 %
Switching frequency	20 Hz

Protection :

Reverse polarity protection	
Short-circuit protection	
Overload protection	
AC magnetic field immunity (AC welding current)	
IEC 61000-4-2 (ESD)	4 kV contact / 8kV air
IEC 61000-4-4 (Burst)	2kV / 5kHz
IEC 61000-4-6 (RF conducted)	3V 150kHz...80MHz
Protection degree	IP67

Materials :

Housing	Zamak
---------	-------

Status indication :

Output	Yellow LED
--------	------------

Connection :

Connector	M8
Cable	PUR, halogen free
Cable length	0,5 m (0/+30 mm)
Cable protection	Silicone-coated fiberglass braided sleeving

Accessories (not included) :

Assembly index (SDPQ30RC, SDPQ30RT, ...)

C1263K05Q3003AS

Welding environment
Q30

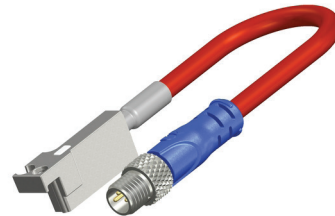

Dimensions :

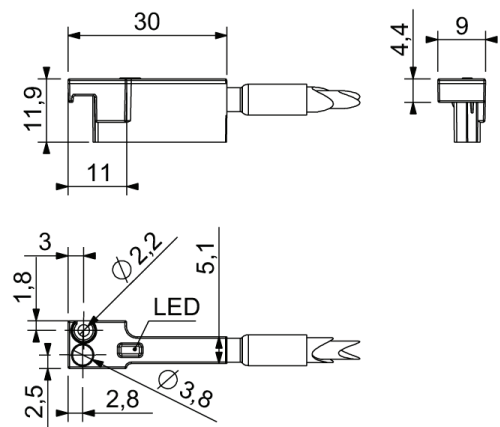

Connection diagram :

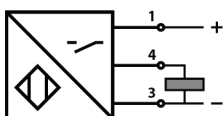

Pin assignment :

