

Technical data :

Output type	PNP
Function	NO
Operating voltage	10...30V DC
Operating current	200 mA
No-load consumption	< 12 mA
Voltage drop	< 2 V
Residual current	< 70 µA
Ambient temperature range	-25...70 °C
Hysteresis	< 1 mm
Switching frequency	20 Hz
Output turn-off delay	20 ms

Protection :

Reverse polarity protection	
Short-circuit protection	
Overload protection	
AC magnetic field immunity (AC welding current)	
IEC 61000-4-2 (ESD)	4 kV contact / 8kV air
IEC 61000-4-4 (Burst)	2kV / 5kHz
IEC 61000-4-6 (RF conducted)	3V 150kHz...80MHz
Protection degree	IP67

Materials :

Housing	PA
Index	Anodized aluminium
Sensing face	PA

Status indication :

Output	Yellow LED
--------	------------

Connection :

Connector	M12
Cable	PUR
Cable length	0,8 m

Accessories (included) :

Fixing index for T-shaped groove T (SDPQ05RT)

Remarks :

Self-extinguishing polyamide housing (UL94-V0)

C126308Q050311

Q5



Dimensions :

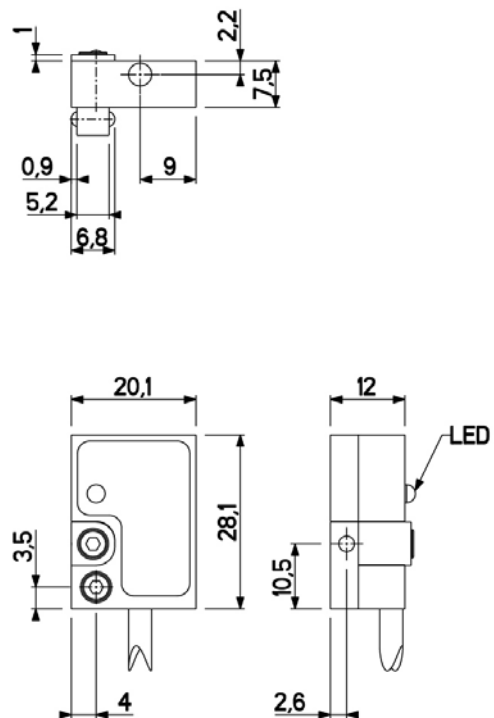

Details view (index) :

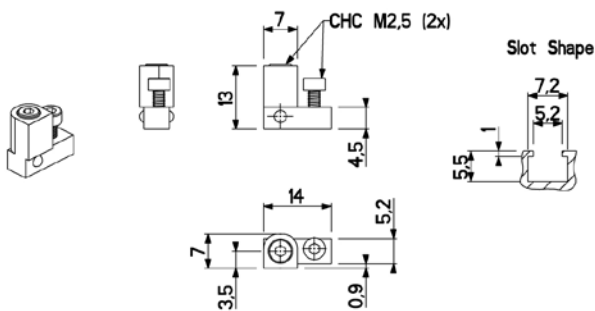

Connection diagram :

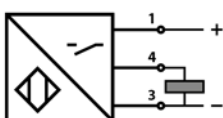

Pin assignment :

