

Technical data :

Output type	PNP
Function	NO
Operating voltage	4,5...28V DC
Operating current	40 mA
No-load consumption	< 10 mA
Voltage drop	< 2 V
Residual current	< 100 µA
Ambient temperature range	-10...60 °C
Switching frequency	500 Hz

Protection :

IEC 61000-4-2 (ESD)	4 kV contact / 8kV air
IEC 61000-4-4 (Burst)	2kV / 5kHz
IEC 61000-4-6 (RF conducted)	3V 150kHz...80MHz
Protection degree	IP67

Materials :

Housing	Plastic
---------	---------

Status indication :

Output	Red LED
--------	---------

Connection :

Connector	M12
Cable	PVC
Cable length	0,5 m (0/+3 cm)
Cable protection	Silicone-coated fiberglass braided sleeving

C126303Q220321TS

Welding environment
Q22



Dimensions :

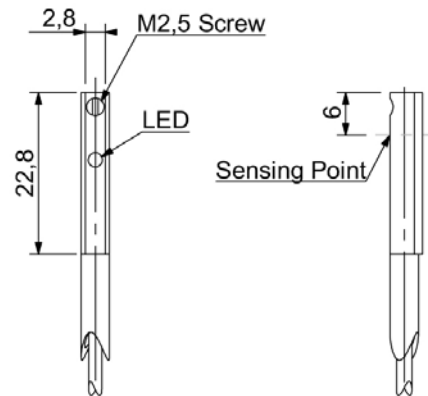

Connection diagram :

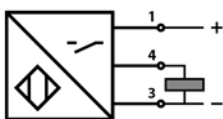

Pin assignment :

