

Technical data :

Rated operating distance (Sn)	5 mm
Mounting mode	Flush
Function	NC
Operating voltage	20...250 V AC/DC (45...65 Hz)
Operating current	3...150 mA
Maximum overcurrent	2,2 A (10 ms / 3 Hz)
Voltage drop	< 6 V
Residual current	< 1,5 mA
Ambient temperature range	-25...70 °C
Hysteresis	3...15 %
Repeatability	< 5 %
Switching frequency	25 Hz AC / 100 Hz DC

Protection :

Non-polarised	
IEC 61000-4-2 (ESD)	4 kV contact / 8kV air
IEC 61000-4-4 (Burst)	2kV / 5kHz
IEC 61000-4-6 (RF conducted)	3V 150kHz...80MHz
Class II insulation	
Protection degree	IP67

Materials :

Housing	Brass, nickel-plated
Sensing face	PA

Status indication :

Output	Yellow LED
--------	------------

Connection :

Cable	PVC (2x0,34mm ²)
Cable length	2 m

Accessories (included) :

2 nickel-plated brass fixing nuts

A139250M180511

M18



Dimensions :

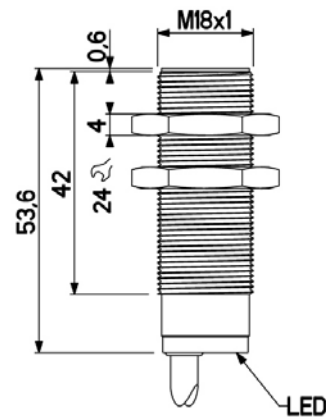

Connection diagram :

