

Technical data :

Rated operating distance (Sn)	10 mm
Mounting mode	Flush
Function	NC
Operating voltage	10...55 V DC
Operating current	1,5...200 mA
Voltage drop	< 5 V
Residual current	< 600 µA
Ambient temperature range	-25...70 °C
Hysteresis	3...15 %
Repeatability	< 5 %
Switching frequency	150 Hz

Protection :

Non-polarised	
Short-circuit protection	
Overload protection	
IEC 61000-4-2 (ESD)	4 kV contact / 8kV air
IEC 61000-4-4 (Burst)	2kV / 5kHz
IEC 61000-4-6 (RF conducted)	3V 150kHz...80MHz
Class II insulation	
Protection degree	IP67

Materials :

Housing	PA
Sensing face	PA

Status indication :

Output	Yellow LED
--------	------------

Connection :

Connector	M12
Cable	PUR
Cable length	0,8 m

Accessories (included) :

- 1 Q26 zamak holder
- 1 zinc-plated steel screw CHC M4-30 mm
- 1 zinc-plated steel screw CHC M4-8 mm
- 1 zinc-plated steel screw CHC M4-6 mm

A1292S1Q261021

Q26



Dimensions :

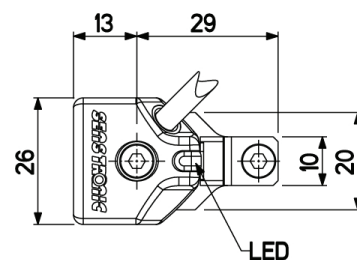
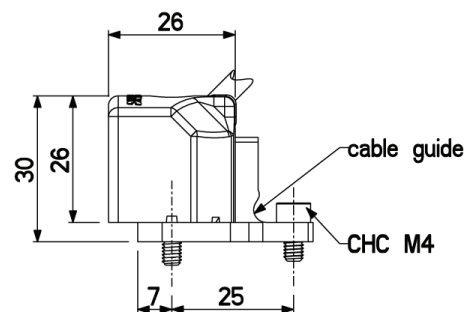

Connection diagram :

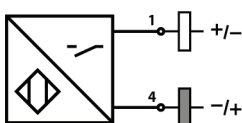

Pin assignment :

