

Technical data :

Rated operating distance (Sn)	2 mm
Mounting mode	Flush
Output type	PNP
Function	NO
Operating voltage	10...30V DC
Operating current	100 mA
Non-Load consumption	< 15 mA
Voltage drop	< 2 V
Residual current	< 70 µA
Ambient temperature range	0...120°C (*)
Hysteresis	2...15 %
Repeatability	< 5 %
Switching frequency	150 Hz

Protection :

Reverse polarity protection	
Short-circuit protection	
Overload protection	
IEC 61000-4-2 (ESD)	4kV Contact / 8kV Air
IEC 61000-4-4 (Burst)	2kV / 5kHz
IEC 61000-4-6 (RF conducted)	3V 150kHz...80MHz
Protection degree	IP67

Materials :

Housing	Stainless steel
Connector	Brass, nickel-plated
Sensing face	Ceramic

Status indication :

Output	Yellow LED
--------	------------

Connection :

Connector	M8
Cable	PUR, halogen free
Cable length	0,5 m (0/+20 mm)
Cable protection	Silicone-coated fiberglass braided sleeving
X	Silicone termination sleeve

Remark :

(*) 0...120°C sensor part, 0...85°C connector part

A1263X05Q200231CH

Welding environment
Q20 High temperature



Dimensions :

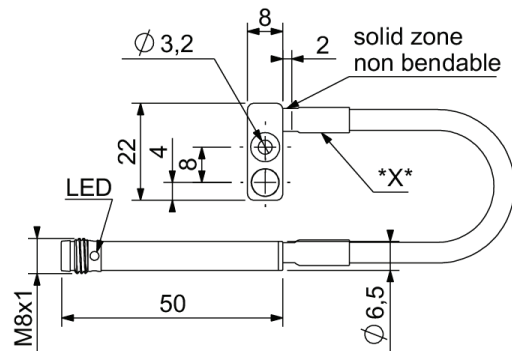

Connection diagram :

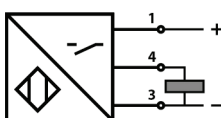

Pin assignment :

