

**Technical data :**

Rated operating distance (Sn)	1,8 mm
Mounting mode	Flush
Output type	PNP
Function	NO
Operating voltage	10...30V DC
Operating current	200 mA
No-load consumption	< 30 mA
Voltage drop	< 2 V
Residual current	< 70 µA
Ambient temperature range	-25...70 °C
Hysteresis	3...15 %
Repeatability	< 5 %
Switching frequency	1 kHz

**Protection :**

Reverse polarity protection	
Short-circuit protection	
Overload protection	
Class II insulation	
Protection degree	IP67

**Materials :**

Main housing	Zamak
Satellite housing	PA
Sensing face	PA

**Status indication :**

Power	Green LED
Output S4	Yellow LED
Output S2	Red LED

**Connection :**

Connector	M12
Cable (satellites)	PUR
LS2 Cable length	95 mm (0/+10 mm)
LS4 Cable length	95 mm (0/+10 mm)

## A1263S2K500165

K500



**Dimensions :**

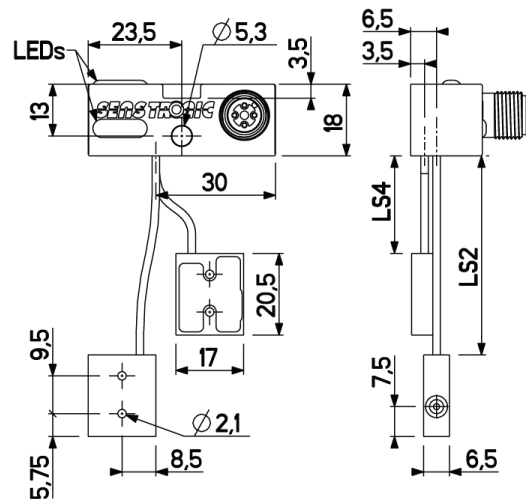

**Connection diagram :**

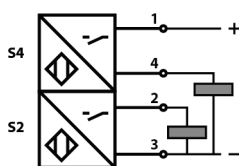

**Pin assignment :**

