

Technical data :

Rated operating distance (Sn)	10 mm
Mounting mode	Flush
Output type	PNP
Function	NO
Operating voltage	10...30V DC
Operating current	600 mA
No-load consumption	< 10 mA
Voltage drop	< 1,5 V
Residual current	< 70 µA
Ambient temperature range	-25...70 °C
Hysteresis	3...15 %
Repeatability	< 5 %
Switching frequency	150 Hz

Protection :

Reverse polarity protection	
Short-circuit protection	
Overload protection	
IEC 61000-4-2 (ESD)	4 kV contact / 8kV air
IEC 61000-4-4 (Burst)	2kV / 5kHz
IEC 61000-4-6 (RF conducted)	3V 150kHz...80MHz
Class II insulation	
Protection degree	IP67

Materials :

Housing	PA
Sensing face	PA

Status indication :

Output	Yellow LED
--------	------------

Connection :

Connector	M12
Cable	PUR
Cable length	0,15 m

Accessories (included):

- 1 Q26 zamak holder
- 1 zinc-plated steel screw CHC M4-20 mm
- 1 zinc-plated steel screw CHC M4-40 mm
- 2 nuts M4 + Z-type washers, zinc-plated steel

A1263F2Q261021

Q26



Dimensions :

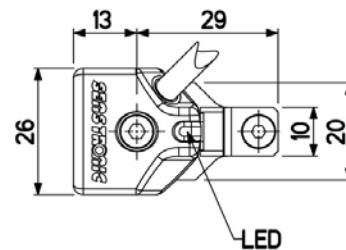
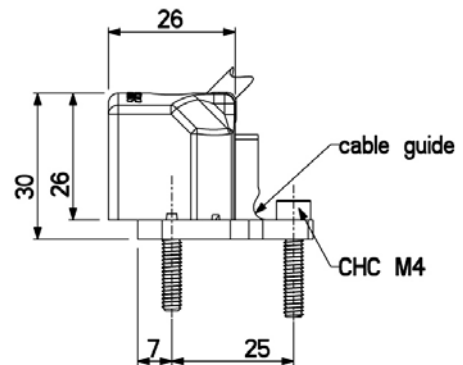

Connection diagram :

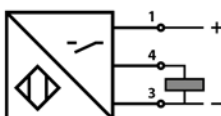

Pin assignment :

