

**Technical data :**

Rated operating distance (Sn)	15 mm
Mounting mode	Flush
Function	NO
Operating voltage	10...55 V DC
Operating current	1,5...200 mA
Voltage drop	< 5 V
Residual current	< 600 µA
Ambient temperature range	-25...70 °C
Hysteresis	3...15 %
Repeatability	< 5 %
Switching frequency	100 Hz

**Protection :**

Non-polarised	
Short-circuit protection	
Overload protection	
IEC 61000-4-2 (ESD)	4 kV contact / 8kV air
IEC 61000-4-4 (Burst)	2kV / 5kHz
IEC 61000-4-6 (RF conducted)	3V 150kHz...80MHz
Class II insulation	
Protection degree	IP67

**Materials :**

Housing	PA
Sensing face	PA

**Status indication :**

Output	Yellow LED
--------	------------

**Connection :**

Connector	M12
Cable	PUR
Cable length	0,8 m

**Accessories (included) :**

- 1 Q26 zamak holder
- 1 zinc-plated steel screw CHC M4-30 mm
- 1 zinc-plated steel screw CHC M4-8 mm
- 1 zinc-plated steel screw CHC M4-6 mm

## A1202S1Q261521

Q26



**Dimensions :**

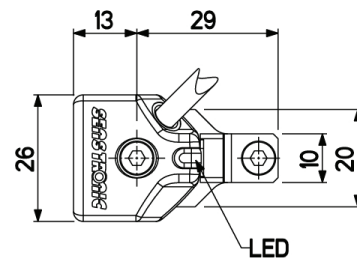
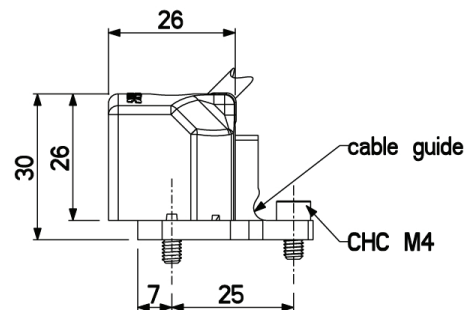

**Connection diagram :**

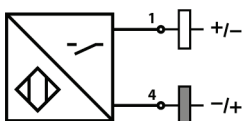

**Pin assignment :**

