

**Technical data :**

Rated operating distance (Sn)	20 mm
Mounting mode	Flush
Function	NO
Operating voltage	10...48V DC
Operating current	1,5... 100 mA
Voltage drop	< 5 V
Residual current	< 600 µA
Ambient temperature range	-25...70 °C
Hysteresis	3...15 %
Repeatability	< 5 %
Switching frequency	250 Hz

**Protection :**

Non-polarised	
Short-circuit protection	
Overload protection	
IEC 61000-4-2 (ESD)	4kV Contact / 8kV Air
IEC 61000-4-4 (Burst)	2kV / 5kHz
IEC 61000-4-6 (RF conducted)	3V 150kHz...80MHz
Class II insulation	
Protection degree	IP67

**Materials :**

Housing	PA
Sensing face	PA

**Status indication :**

Output	Yellow LED
--------	------------

**Connection :**

Connector	M12
Cable	PUR
Cable length	0,8 m

**Accessories (included) :**

- 1 Q40 zamak holder
- 1 zinc-plated steel screw CHC M4-40 mm
- 1 stainless steel spring washer, Type S

## A120214Q402021

Q40



**Dimensions :**

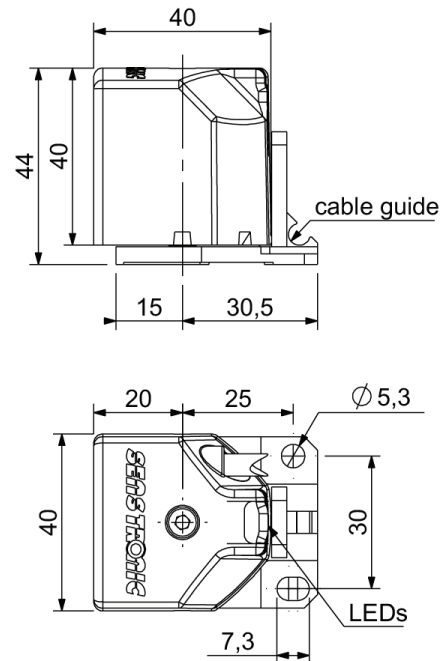

**Connection diagram :**

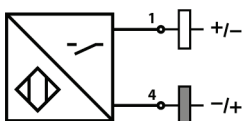

**Pin assignment :**

