

**Technical data :**

Rated operating distance (Sn)	2 mm
Mounting mode	Flush
Function	NO
Operating voltage	10...55 V DC
Operating current	1,5...100 mA
Voltage drop	< 5 V
Residual current	< 600 µA
Ambient temperature range	-25...70 °C
Hysteresis	3...15 %
Repeatability	< 3 %
Switching frequency	300 Hz

**Protection :**

Non-polarised	
Short-circuit protection	
Overload protection	
IEC 61000-4-2 (ESD)	4 kV contact / 8kV air
IEC 61000-4-4 (Burst)	2kV / 5kHz
IEC 61000-4-6 (RF conducted)	3V 150kHz...80MHz
Class II insulation	
Protection degree	IP67

**Materials :**

Housing	Brass, nickel-plated
Sensing face	PA

**Status indication :**

Output	Yellow LED
--------	------------

**Connection :**

Connector	M12
Cable	Halogen free PUR
Cable length	0,8 m

**Accessories (included) :**

2 nickel-plated brass fixing nuts

## A120200M120211

M12



**Dimensions :**

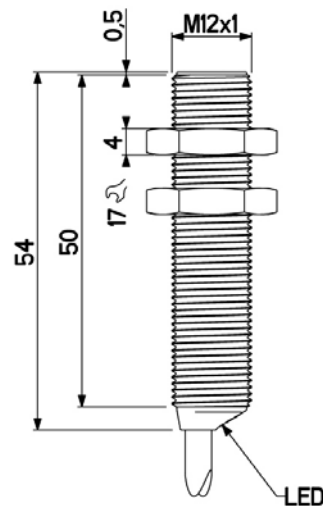

**Connection diagram :**

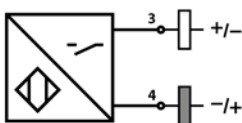

**Pin assignment :**

