

**Technical data :**

Rated operating distance (Sn)	6,3 mm
Mounting mode	Flush (*)
(*) Flush mountable as shown in diagram enclosed	
Function	NO
Operating voltage	10...55 V DC
Operating current	1,5...100 mA
Voltage drop	< 5 V
Residual current	< 600 µA
Ambient temperature range	-25...70 °C
Hysteresis	3...5 %
Repeatability	< 5 %
Switching frequency	300 Hz

**Protection :**

Non-polarised	
Short-circuit protection	
Overload protection	
IEC 61000-4-2 (ESD)	4 kV contact / 8kV air
IEC 61000-4-4 (Burst)	2kV / 5kHz
IEC 61000-4-6 (RF conducted)	3V 150kHz...80MHz
Protection degree	IP67

**Materials :**

Housing	Brass, nickel-plated
Sensing face	PA

**Status indication :**

Output	Yellow LED
--------	------------

**Connection :**

Connector	M12
Cable	PUR
Cable length	1,2 m

## A120200L180611

L18

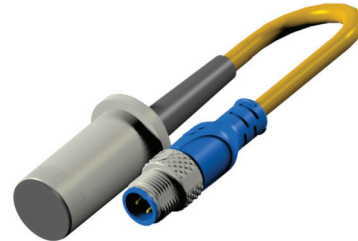

**Dimensions :**

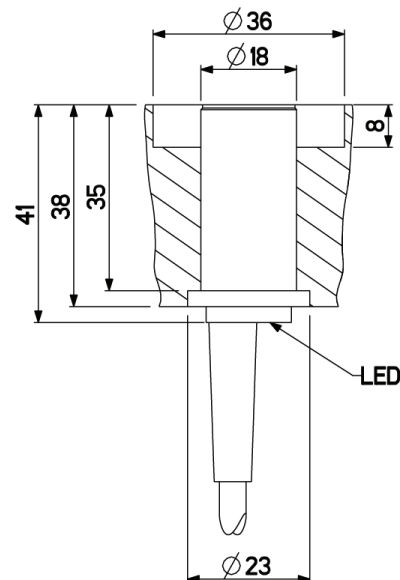

**Connection diagram :**

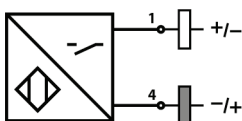

**Pin assignment :**

